

**此页不印刷**

形式：骑马钉（24P）

尺寸：110x159mm

材质：120g双铜

工艺：单色 双面印刷，封面覆哑膜

# ELECTRIC BICYCLE

## User Manual

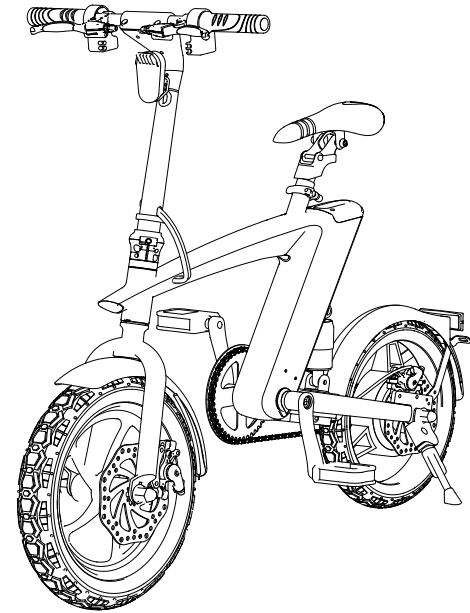

## About the manual

- Thank you for choosing our electric bicycle series products!
- The safety instructions and precautions for electric bicycles are introduced in the user manual, Please read it carefully for the first using. If it is not used in accordance with the instructions in the manual, it may cause danger, and the company will not bear any responsibility for the personal injury or property loss caused by this!
- For the safety of you and others, please read the manual carefully before using to ensure that you can drive correctly and safely!
- If you have any questions during use, or cannot get the information from the manual, please contact your dealer in time!

## INDEX

1. Packing list .....	3
2. Function Introduction .....	4-5
3. Product assembly .....	6-8
4. How to ride .....	9-11
5. Safety notes .....	12-16
6. Battery instructions .....	17-18
7. Basic parameters .....	19
8. Daily maintenance .....	20
9. Warranty card .....	21

## Packing list

### 1. The whole scooter

Electric bike\*1

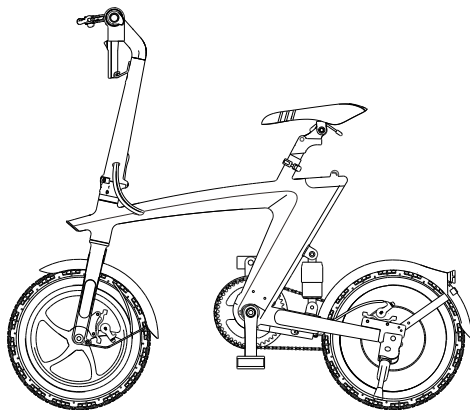

### 2. Accessories

Seat\*1



Pedal\*2



Charger\*1

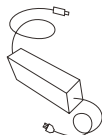

Wrench\*2

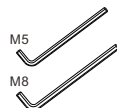

User Manual\*1



Chain\*1



Left crank\*1



Right crank\*1



Crank screw\*1

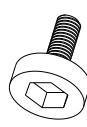
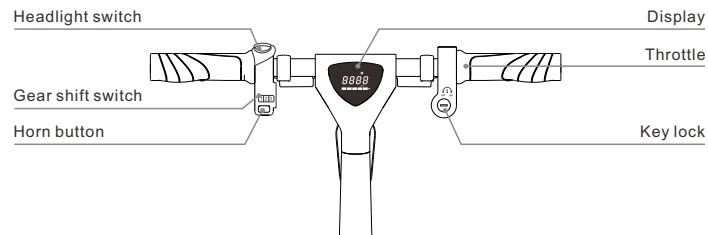
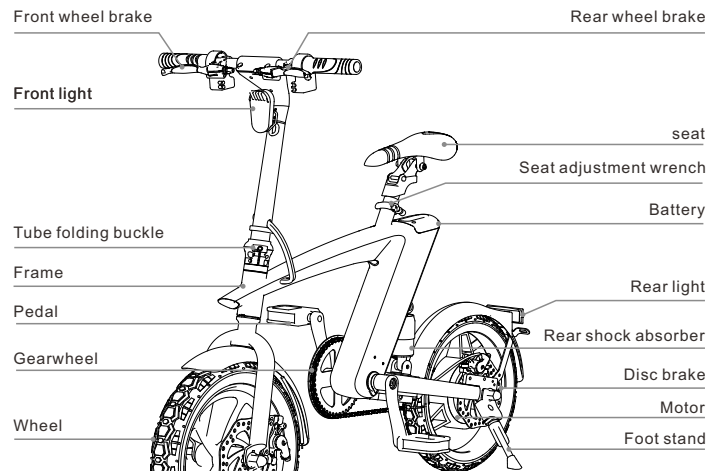

Plate holder\*1



\*If anything is missing, please contact the dealer in time!

## Product function introduction



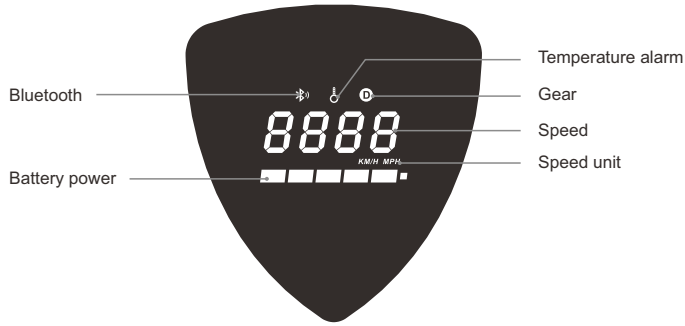

Display content illustration

### Function Description

- ① Display: battery power, speed, gear ect;
- ② Key lock: Insert the key, turn clockwise to the ON position to turn on, and turn counterclockwise to the OFF position to turn off;
- ③ Throttle: Move the throttle to ride in pure electric mode;
- ④ Headlight switch: push the switch to the ON position to turn on the front light, push it to the OFF position to turn off the front light;
- ⑤ Photosensitive switch: When the ambient light becomes dark, the front and rear lights will automatically turn on when the headlight switch is not turned on;
- ⑥ Gear shift switch: Toggle the switch to switch 1, 2, and 3 gears in sequence from  
 Low speed mode: without D  
 Normal model: white D  
 High-speed mode: Red D
- ⑦ Horn button: short press the button, the horn will "beep, beep".
- ⑧ Front and rear brakes: hold the brakes, the car will slow down and stop.

**Note: When the brake is active, turning the throttle knob to accelerate is invalid!**

## Product assembly

### 1. Open and fix the handle bar of the e-bike

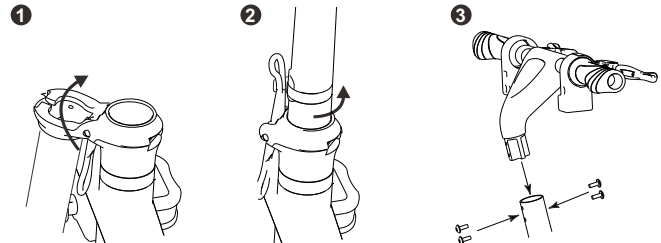
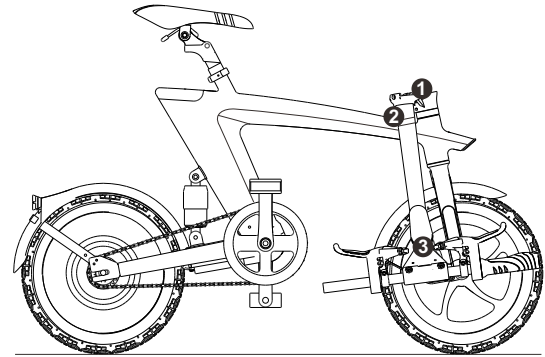

1. Lift the pole and the front of scooter, Fasten the folding buckle of pole.
2. Turn the fix ring of the folding buckle to fasten the spanner, prevent opening of folding buckle.
3. Align the handle bar of the scooter with the upper end of the pole, and lock the front with the four screws provided.

⚠ Note: Shake the handlebar after installation, if it becomes loose, pls adjust the screw as shown in the figure. The screw cannot be adjusted too tightly. If it is too tight, it will be difficult or impossible to open the folding buckle wrench.

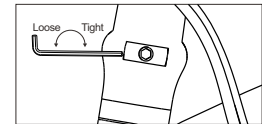

## 2. Install brake lever

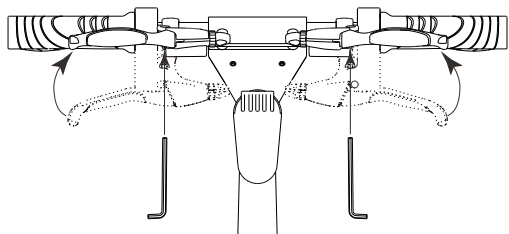

Turn the brake lever up to be almost flush with the instrument, and use an Allen key to tighten the screw.

## 3. Install pedal

Left

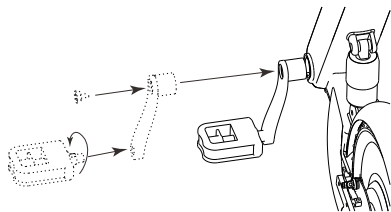

- Install the crank without tooth disc on the left shaft of the scooter, and lock it clockwise with the screws provided
- Install the pedal marked with "L" on the left crank, and pay attention to the thread direction of the pedal is counterclockwise assembly

Right

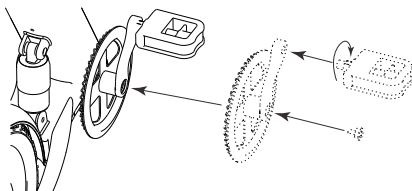

- Install the crank with chainring on the shaft on the right side of the car, and lock it clockwise with the equipped screw;
- Install the pedal marked "R" on the right crank, and pay attention to the clockwise thread direction of the pedal during installation;

## 4. Install battery pack

Install the battery

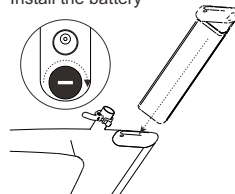

Align the battery with the guide rail and insert it, insert it to the end and turn the key clockwise to lock it.

Remove the battery



Remove the silicon cover, turn the battery lock 90° anticlockwise and pull the rope to take out the battery.

## 5. Install the chain

To install the chain, pass one end of the chain through the chainring and one end through the flywheel of the motor, buckle the buckle into the chain, add a washer, and then clamp the circlip.

Note: It is better to tighten the chain and lock the buckle just to buckle both ends of the chain.

If it is too tight to buckle or too loose, the screw needs to be adjusted.

The adjustment method is as follows.

- Use M19 wrenches to loosen the fixing screws on both sides of the motor;
- Use an M10 wrench to adjust the tightness in the direction shown in the figure;
- Just tighten the screws that fix the motor.

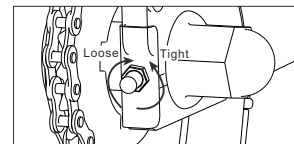
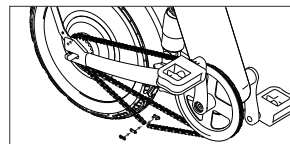

## 6. Install the bike seat

Open the seat tube locking wrench, insert the seat into the tube, adjust the height of the seat and tighten the wrench.



Note: Pay attention to the safety line when adjusting the height of the seat. The safety line cannot exceed the saddle tube to prevent danger!

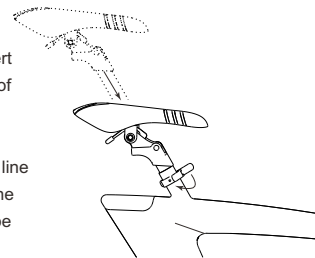

## How to ride

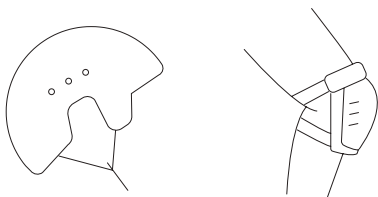

1. There is a risk of falling and injury during riding, so please wear helmets, knee pads, elbow pads and other protective tools.

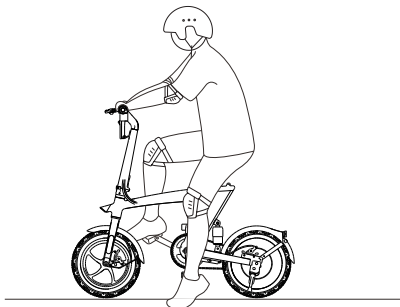

2. Adjust the seat to a height suitable for your comfortable riding (appropriate height: when the foot is at the lowest point, the knee angle is about 25 to 35 degrees, this height is the most suitable).

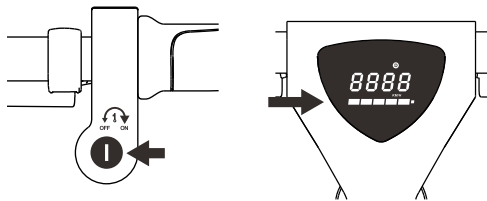

3. Insert the key, turn the key clockwise to the ON position to turn on the E-bike and check the battery level.

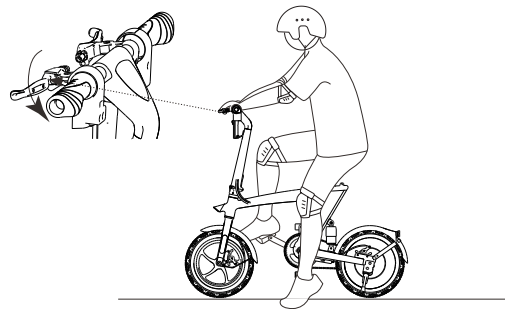

4. Hold the brake tightly, straddle the bike with your right foot, step on the pedal and sit down.

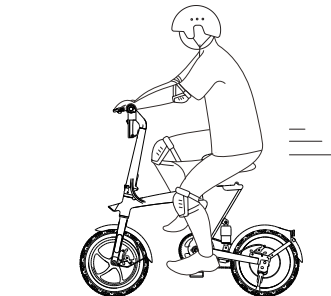

5. Slowly release the brake and press the left foot lightly on the ground to make the bike start to slide forward slowly. At the same time, use your right foot to push forward forcefully. Step on the left foot pedal to start pedaling alternately. Hold the handlebar firmly with both hands. Just like riding a bicycle.



Note: When riding an electric bike for the first time, it is best to have someone help stabilize the bike and keep the bike balanced.

6. This electric bicycle provides three cycling modes (fitness mode, electric power mode and electric mode).
- Fitness mode: When the motor power is turned off, full-time manual cycling can reach the goal of fitness just like riding an ordinary bicycle;
  - Electric power mode: Turning on the motor power, and the electric bike control system will automatically output an electric power according to the intensity of pedaling during cycling, making the riding very easy. Meanwhile, the riding distance can reach the maximum range.
  - Electric mode: Switch on the motor power and turn the throttle handle to ride in electric mode. There is no need for manual pedaling mode, which can save energy and ease riding.

 Note: when used for the first time, the throttle should be slowly turned to speed up, to prevent the acceleration caused by too fast then out of control!

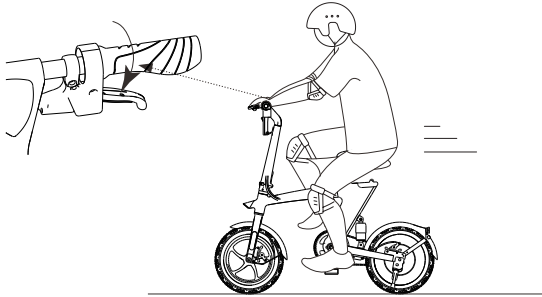

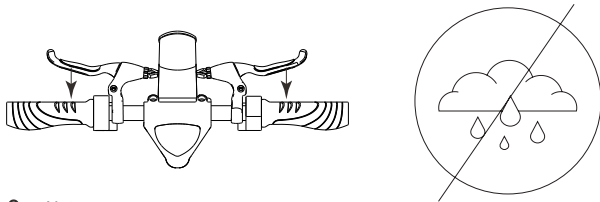

7. loosen the throttle knob can slow down the speed, vigorously grip the brake handle to do emergency brake.



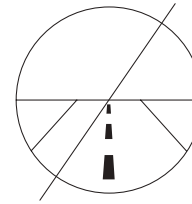

-  Note:
- When riding in rain and snow, the braking distance will be extended, so please pay attention to slow down;
  - Use the rear brake during normal driving, and the front and rear brakes should be used together for emergency braking. Do not use the front brake for emergency braking during high-speed driving, as the front brake at high speed may cause the danger of rolling over!

## Safety notes

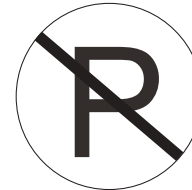

-  1. Please follow the traffic laws and regulations when using electric bikes. It is forbidden to ride electric bikes into the motorway



-  2. Electric bikes should not be parked in the building foyer, evacuation corridor or safety exit

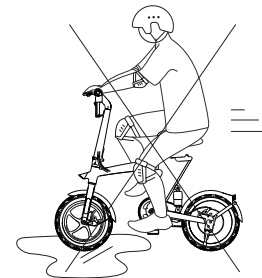



-  3. It is prohibited to ride on the road with severe water accumulation. The road condition of the water accumulation is unknown, which may easily cause danger.

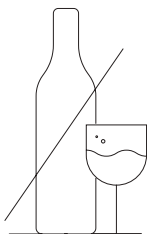



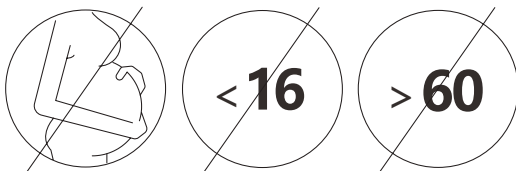

 4. Do not ride Electric bicycles after drink.

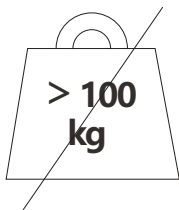

 5. Pregnant women and users under the age of 16 or over 60 are prohibited to ride.



 6. The maximum load of electric bikes is 100kg.

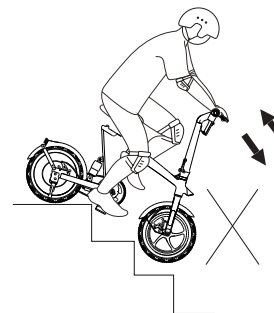

 7. It is prohibited to ride electric bicycles up and down stairs or jumping obstacles.

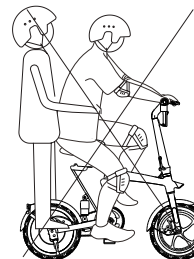

 8. It is forbidden for multiple people to ride the same electric bicycle at the same time or ride with children in their arms.

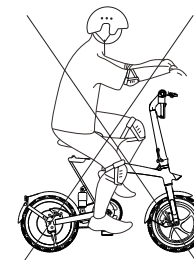

 9. It is forbidden to leave the handlebar with both hands while riding.

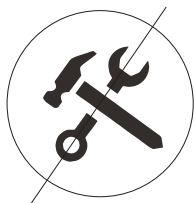

⚠ 10. It is forbidden to modify the electric bicycle by yourself. It may cause unstable operation of the electronic system and cause danger when riding.

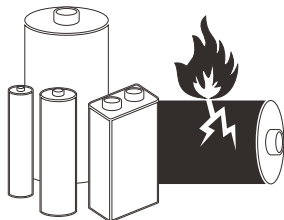

⚠ 11. It is forbidden to modify the battery of an electric bicycle without permission. Modification of the battery is dangerous, and improper operation may cause the battery to explode or catch fire.



⚠ 12. Please try to avoid riding in rain or snow. If you need to ride, slow down and avoid emergency braking.

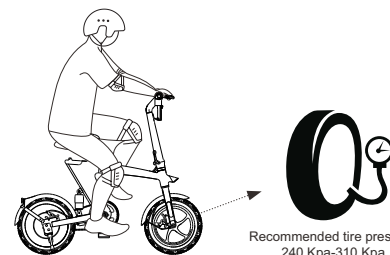

⚠ 13. Before riding an electric bicycle, please check the body and tires carefully to ensure that there are no signs of looseness or damage.

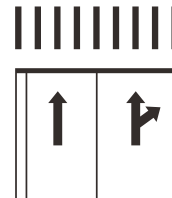

⚠ 14. When riding, braking, please observe the intersection to avoid unnecessary damage to yourself or surrounding objects, people and small animals.

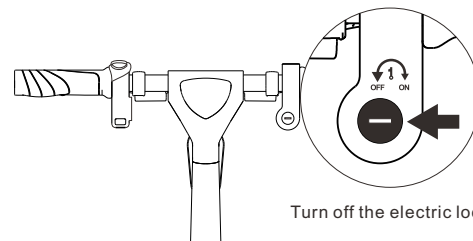

⚠ 15. Please turn off the electric lock when walking with Electric bicycle prevent accidental acceleration of the throttle.

## Battery Instruction

The instruction shows how to charge and maintain the battery, some safety notices and the specification. Please use the battery properly according to this instruction to prolong the battery life and its performance

### 6.1 Battery Parameters

Name	Parameter	Name	Parameter	Name	Parameter
Type	Li-ion battery	Battery Capacity	10Ah	Rated Voltage	36V
Max Charging Voltage	42V	Max Charging Current	2A	Charging time	5-6h
Temperature	-10-40°C	Charging Temperature	0-40°C	Store Time (-10-40°C)	3 months (full charge)

### 6.2 Battery Safety

1. In order for the electric bicycle to work stably and efficiently, the battery must be charged and used within the temperature range required by the battery specification;
2. Before installing and using the battery, please unplug the charger. It is dangerous to do anything related to the electric bicycle during the charging process;
3. It is forbidden to disassemble or pierce the battery pack shell to avoid short circuit caused by metal objects contacting the battery contacts, otherwise it may cause battery damage or personal injury.
4. It is forbidden to throw the battery into water, fire (including near stove, heater, etc.) or expose it to high temperature (50°C), otherwise it may cause battery failure, overheating, or even risk of fire.
5. Water in the battery may cause damage to the internal circuit and risk of fire or explosion. If the battery is suspected of being exposed to water, please stop using the battery immediately and send it to after-sales testing.
6. Only use the original charger to charge, otherwise there is a danger of damage to the battery or fire.
7. If the battery is damaged, emits peculiar smell, smoke or overheating, please do not continue to use the battery, and avoid other objects in contact with the battery.
8. Please fully charge the battery before storing after each use, which will help extend the battery life.
9. Do not place the battery in a high temperature higher than 50°C or a low temperature environment lower than -20°C.
10. When not in use for more than 30 days, please fully charge it first, store it in a cool and dry place, and fully charge it at least once every 90 days, otherwise the battery may be damaged and this damage is not covered by the warranty.
11. Avoid recharging when the battery is completely exhausted, and try to charge as soon as possible, which can greatly extend the battery life. In addition, when used at room temperature, the battery pack can exert a higher range and performance; and if used in an environment below 0°C, the battery life and performance will decrease. Typically, in an environment of -10°C, the cruising range may be only half or lower than that at room

12. Improper disposal of used batteries may seriously pollute the environment. Please abide by local regulations when disposing of this battery pack.



#### Reminder:

1. When the internal temperature of the battery exceeds 50°C, the battery is in a protected state and cannot be charged!
2. A fully charged electric bicycle will be no battery after about 90-120 days of standby. If it is not charged in time, it may cause damage to the battery due to excessive discharge. This damage is irreversible and out of free warranty.

### 6.3 Charging steps

Open the dust cover on the battery, insert the DC plug of the charger into the charging base of the battery, and then plug the AC plug of the charger into the AC power (100-240V; 50/60Hz) socket, the indicator is red and charging starts

#### Charging method A:

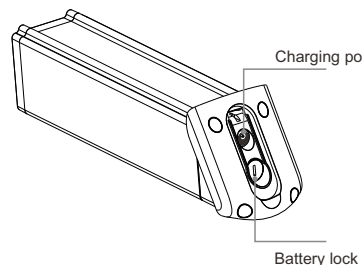

#### Charging method B:

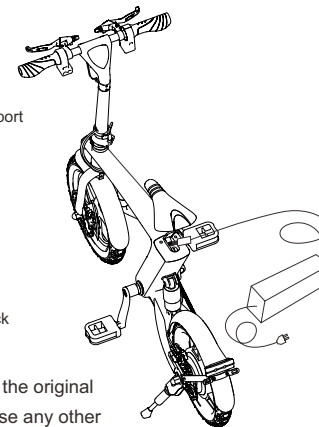

When charging, you can only use the original standard power adapter. Do not use any other to avoid danger caused by power mismatch.

## Parameters

<b>Item</b>	Product name	Electric bicycle
	Item No.	TDT001Z
<b>Size</b>	Unfold size	1180 x 470 x 1090mm
	Folded size	1180 x 350 x 760mm
<b>Net weight</b>	Net weight	20Kg
<b>Riding</b>	Max load	100Kg
<b>Bike specification</b>	Max speed	25KM/h
	Max range with power assistant mode	60Km
	Climbing angle	15°
	Working temperature	0-40°C
	Store temperature	-20-45°C
<b>Battery specification</b>	Rated voltage	36V
	maximum charging voltage	42V
	Capacity	10Ah / 360Wh
<b>Motor parameter</b>	Mode of motor	Permanent magnet brushless
	Motor power	250W
	Rated voltage	36V
<b>Charger parameter</b>	Input voltage	100-240Vac 50/60Hz
	Input current	2A MAX
	Output voltage	42V DC
	Output current	2A
	Charging time	5-6H
<b>Tire</b>	Tire size	14 inch
	Recommended tire pressure	240 Kpa-310 Kpa

## Daily maintenance

### 8.1 Cleaning and storage of electric bikes

If there are stains on the surface of the electric bike, Wipe with a damp soft cloth; if the plastic parts of the body are scratched, Use sandpaper or other abrasive materials for polishing.



#### Reminder:

- It is forbidden to use alcohol, gasoline, kerosene or other corrosive and volatile chemical solvents to clean, otherwise it will seriously damage the appearance and internal structure of the bike.
- It is forbidden to use high-pressure water guns to spray and flush. When cleaning the electric bicycle, make sure the bike is turned off, and the charger has been unplugged and the dust cover of the charging port has been fastened, otherwise it may cause electric shock or major failure due to the bike was flooded.
- Electric bikes need to be stored in a cool and dry indoor place. Try to avoid storing outdoors for a long time. Sun exposure, overheating, and cold outdoor environments will accelerate the appearance of electric bikes and tire aging, and reduce the use of electric bicycles and their lithium battery life.

### 8.2 Inflation and maintenance of tires

The tires of this product are pneumatic tires. When the tire height sinks 20%-30%, it needs to be inflated. The recommended inflated tire pressure is 240 Kpa-310 Kpa.

The tire is inflated at least once in 2-3 months. Regular inspection of the inflation can reduce the puncture situation and extend the life of the tire.

## Warranty card

### 9.1 The product has passed the inspection of the quality control department and allowed to be sold

Please keep the warranty card and purchase invoice properly, and present the warranty card and purchase invoice when repairing.

Effective date :

Quality inspection pass seal:

### 9.2. Warranty Card

Username		Gender		Age	
Mailing address					
Phone				Zip code	
Purchase address					
Price			Sales order number		
Description & Specification			Body number		
Dealer signature			User signature		



Please keep the warranty card and purchase invoice as after-sales proof. This card must be provided during the warranty. If this card is not provided or the card is altered privately, the company has the right to do non-warranty treatment!